

we engineer your progress

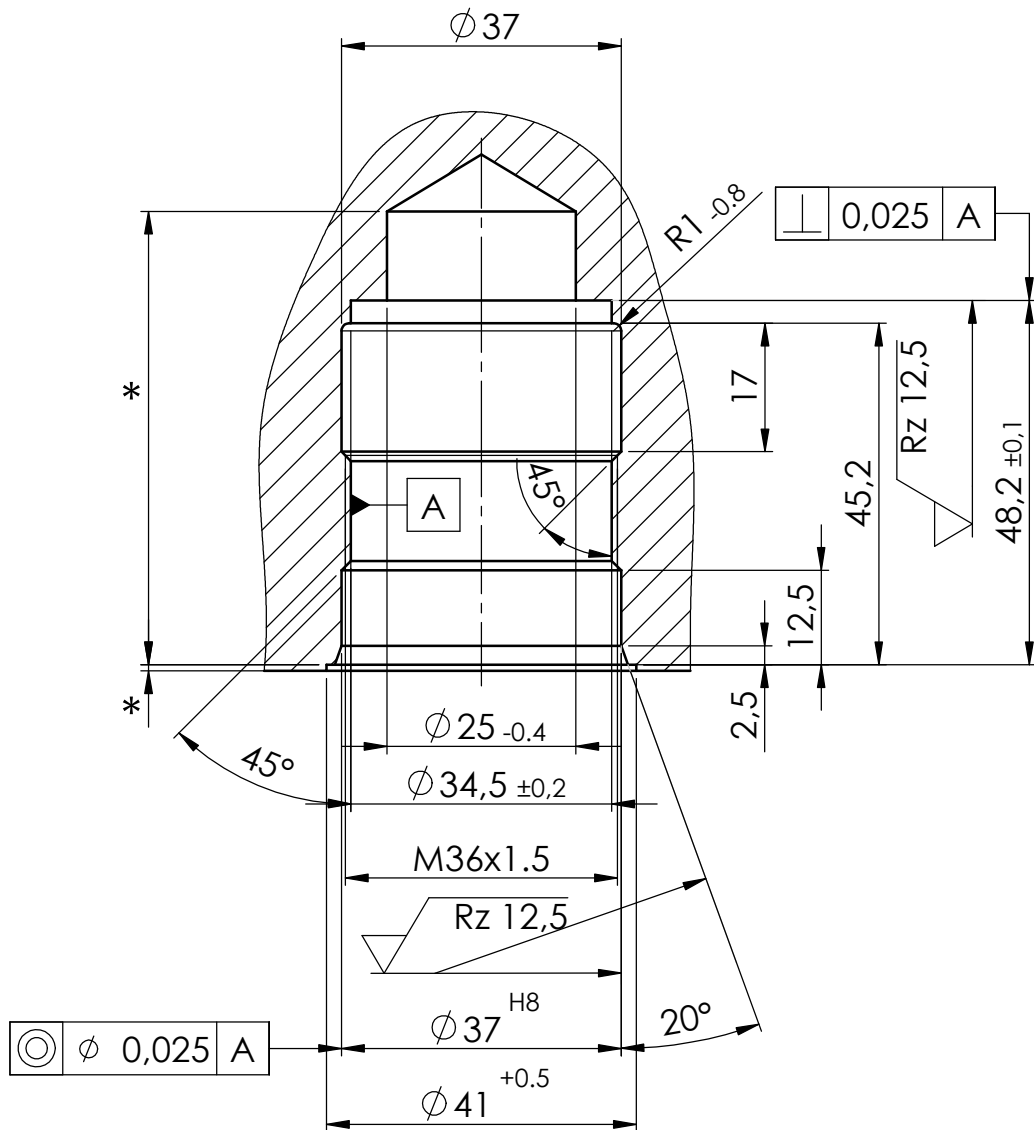

Bore diameter after fitting
max. 0.5 mm smaller.

Dimensions in millimeters

workpiece edge DIN EN ISO 13715

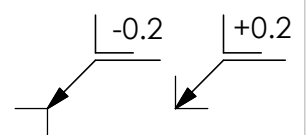

37 H8	$\begin{matrix} +0.039 \\ 0 \end{matrix}$
fitting	diameter