

## Table of Contents

<b>1</b>	<b>Product Description</b> .....	<b>2</b>
1.1	Intended purpose.....	2
1.2	Mounting location (Recommendation).....	2
1.3	Function.....	2
1.4	Properties.....	2
<b>2</b>	<b>Technical Data</b> .....	<b>3</b>
<b>3</b>	<b>Ordering Information</b> .....	<b>4</b>
3.1	Type Code.....	4
3.2	Versions currently available.....	4
<b>4</b>	<b>Description of Characteristics in Accordance with Type Code</b> .....	<b>5</b>
4.1	Characteristic 1: Variant.....	5
4.2	Characteristic 2: Connections.....	5
4.3	Characteristic 3: Input flow rate.....	6
4.3.1	Characteristics.....	6
4.4	Characteristic 4: Pressure Setting (P).....	6
4.5	Characteristic 5: Volume flow setting (Q).....	6
4.6	Characteristic 6: Output flow rate.....	7
4.7	Characteristic 7: Check Valve (CV) or Throttle Check Valve (TCV).....	7
4.8	Characteristic 8: Pressure relieve (H).....	7
<b>5</b>	<b>Installation</b> .....	<b>8</b>
5.1	General remarks.....	8
5.2	Connection suggestion.....	8
5.3	Installation - space.....	8
5.3.1	Tightening torque.....	8
5.4	Setting the output flow rate.....	8
<b>6</b>	<b>Notes, Standards and Safety Requirements</b> .....	<b>9</b>
6.1	General remarks.....	9
6.2	Standards.....	9
<b>7</b>	<b>Accessories</b> .....	<b>9</b>

## 1 Product Description

The flow control valve FC1X of type 2P is designed for closed-centre hydraulic systems. The output flow rate can be controlled electrically-proportional. The output pressure limiting can also be controlled electrically-proportional or set mechanically. The volume flow to and the pressure at the consumer is independent of the pressure and the volume flow of the main functions in the machine.

### 1.1 Intended purpose

The flow control valve is used for the division of a regulated volume flow from the pump flow rate in a hydraulic system for operating an additional consumer. The additional consumer has no priority over the main functions.

### 1.2 Mounting location (Recommendation)

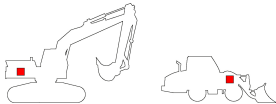

The flow control valve is installed in closed-center systems teed between the pump and the main control valve in parallel to the main control valve of the construction machine.

### 1.3 Function

The volume flow is controlled electrical-proportional with the electric current to the piloting valve (1). To achieve a high accuracy of the adjusted volume flow, the use of a current-regulated control (PWM) is recommended.

The pressure relief valve (2) may also be controlled electrical-proportional. Again, the use of a current-regulated control (PWM) is recommended.

The pressure limiting can be set mechanically to the desired maximum pressure. In this case the electrical-proportional piloting valve (2) is replaced by a mechanically adjustable valve.

The piloting valve (1) can also be actuated ON/OFF. In this case, the maximum output flow rate can be limited mechanically.

For applications where the pressure to the attachment can not relieve itself when switched off, the flow control valve can optionally be ordered with a relief nozzle (3). This nozzle is located between the connection to the consumer and the tank connection and is automatically used when the flow control valve is switched off.

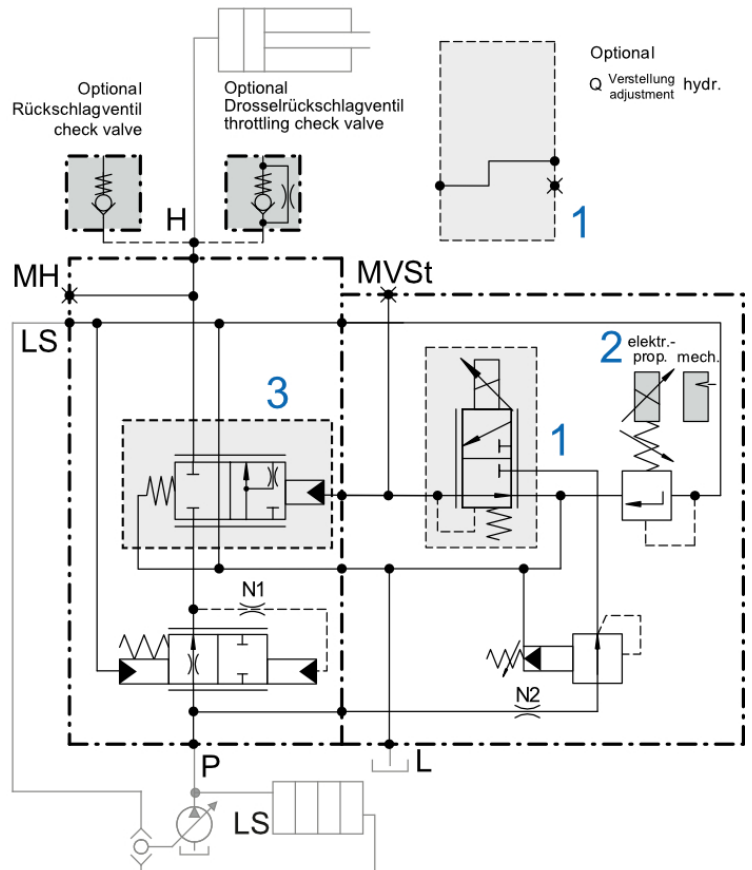
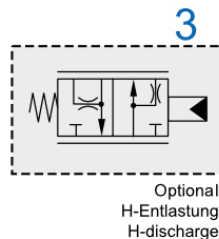

### 1.4 Properties

- Electrical proportional control of output flow rate and output pressure limitation
- Used with consumers with high demands on the accuracy of the volume flow
- Simple operation of different consumers with varying settings for flow rate and pressure relief

## 2 Technical Data

	Units	FC1-2P-G1	
Installation position		Any	
Weight	kg	14,2	
Max. input pressure (P)	bar	420	
Adjustable attachment pressure	bar	120-420	
Output flow rate accuracy	%	± 8	
Maximum recommended tank pressure (L)	bar	< 1	
Maximum pilot pressure VST (only with option "VSt externally")	bar	< 50	
Maximum input flow rate (P)	l/min	230	350
Minimum input flow (P)	l/min	30	
Hydraulic fluid		Mineral oil (HL, HLP) conforming with DIN 51524, other fluids upon request	
Hydraulic fluid temperature range	°C	-20 to +80	
Ambient temperature	°C	< +50	
Viscosity range	mm <sup>2</sup> /s	2.8 - 500	
Contamination grade		Filtering conforming with NAS 1638, class 9, with minimum retention rate $\beta_{10} \geq 75$	
Port P, supply port		G1" (ISO 1179-1)	
Port H, consumer port		G1" (ISO 1179-1)	
Port VSt, pilot port		G ¼" (ISO 1179-1)	
Port L, drain line		G ¼" (ISO 1179-1)	
Port MH, MVSt, measuring ports		G ¼" (ISO 1179-1)	
Port LS, Load sensing		G ¼" (ISO 1179-1)	
Supply voltage	VDC	12 or 24 +/-10%	
Electrical control	Hz	PWM- frequency 140- 150 Hz	
Maximal current I <sub>MAX</sub> :	A	solenoid valve pressure: 12V: 1,76A at 4,7 Ω      24V: 0,88A at 18,70 Ω	
	A	solenoid valve volume flow: 12V: 1,5A at 5,3 Ω      24V: 0.75A at 21,20 Ω	
Solenoid duty cycle	%	100	
Protection class according to DIN 40050	DIN 43650:	bis IP65	
	AMP - JT:	bis IP67	
	Deutsch DT04-2P:	bis IP69	
		(with appropriate mating connector and proper fitting and sealing)	

### 3 Ordering Information

#### 3.1 Type Code

<b>FC1X</b> 00	<b>2P</b> 01	<b>03F</b> 02						
00	Product group	Flow control valve for one-way applications						<b>FC1X</b>
01	Variant	proportional operation						<b>2P</b>
02	Connections	supply line (P), consumer port (H)	G1" - ISO 1179-1			<b>03F</b>		
03	Maximum output volume flow (Q <sub>max</sub> )	l/min						230
								350
04	Actuation pressure setting (P)	12V, AMP JPT connector					<b>12P002</b>	
		12V, DEUTSCH connector					<b>12P003</b>	
		24V, AMP JPT connector					<b>24P002</b>	
		24V, DEUTSCH connector					<b>24P003</b>	
		mechanically adjustable					<b>MAN000</b>	
05	Actuation Volume flow setting (Q)	12V, AMP JPT connector					<b>12P002</b>	
		12V, DEUTSCH connector					<b>12P003</b>	
		24V, AMP JPT connector					<b>24P002</b>	
		24V, DEUTSCH connector					<b>24P003</b>	
		hydraulically proportional					<b>HYP03B</b>	
06	check valve (CV) Throttle check valve (TCV)	no check valve					00	
		CV 25S 427.071.323.9 G1"					02	
		TCV 25S 427.071.322.9 G1"					14	
07	Piloting pressure	internal					1	
		external (G ¼)					0	
08	pressure relief (H)	pressure relief					1	
		No pressure relief					0	

XXX – Permanent preset characteristics    XXXX – Characteristics adjustable by customer

#### 3.2 Versions currently available

The versions listed below are available as standard. Further versions as part of the options given on the type code can be configured upon request.

Designation	Type Code	Part No.
FCX-2P G1 350LPM P-24VPROP-DT Q-24VPROP-AMP NO CHECK VALVE INT PIL NO RELIEF	FC1X -2P -03F -350 -24P003 -24P002 -00 -1 -0	237.364.631.9
FCX-2P G1 230LPM P-24VPROP-DT Q-24VPROP-AMP AMP NO CHECK VALVE INT PIL NO RELIEF	FC1X -2P -03F -230 -24P003 -24P002 -00 -1 -0	237.364.632.9
FCX-2P G1 350LPM P-MAN Q-24VPROP-AMP DEUTSCH NO CHECK VALVE INT PIL NO RELIEF	FC1X -2P -03F -350 -MAN000 -24P003 -00 -1 -0	237.364.636.9

## 4 Description of Characteristics in Accordance with Type Code

### 4.1 Characteristic 1: Variant

The valve of type 2P controls the output volume flow and the output pressure limitation electrical-proportional. Optionally, the output pressure limitation can be set mechanically.

### 4.2 Characteristic 2: Connections

G1" - ISO 1179-1

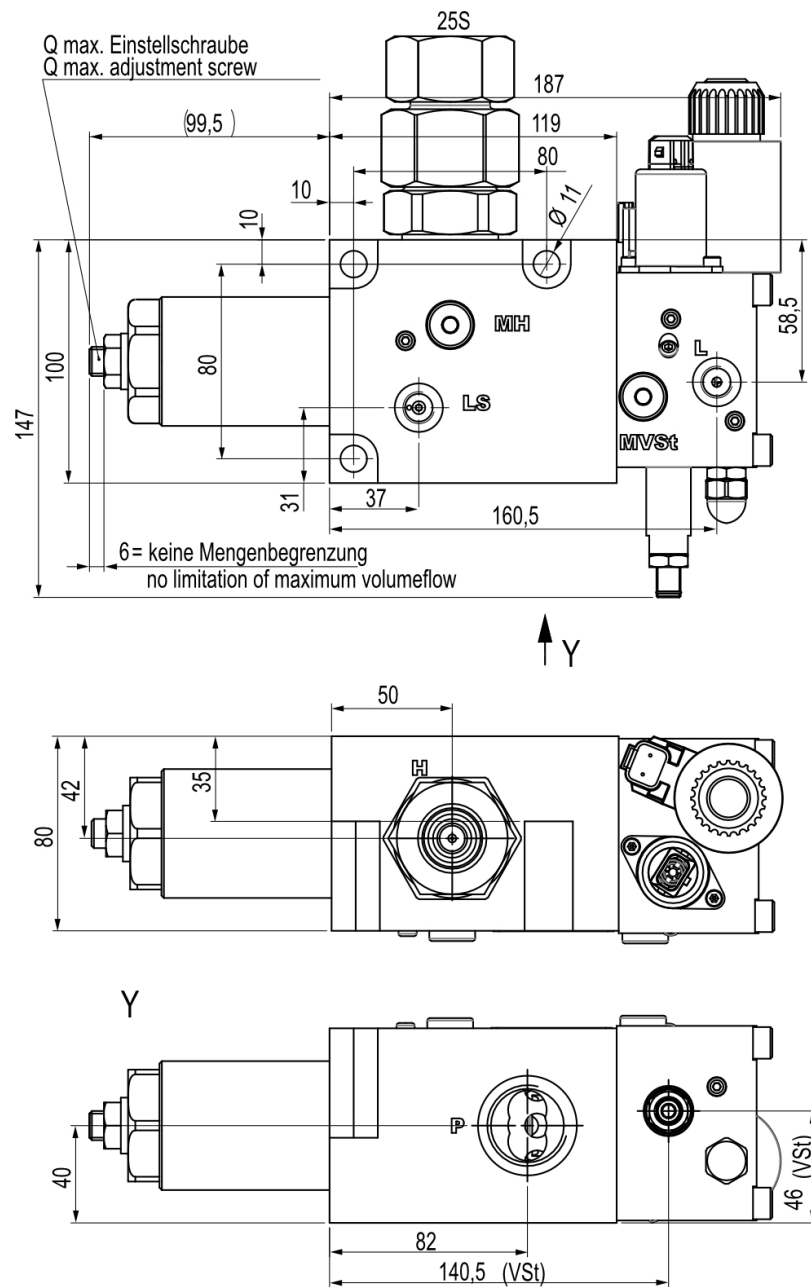

### 4.3 Characteristic 3: Input flow rate

The valves are 2-way current regulators. The maximum input volume flow corresponds to the output volume flow and is 230 l/min, or 350 l/min.

#### 4.3.1 Characteristics

Pressure Valve Characteristic:  
Pressure depending on the electric current  
Basic setting 120 bar (0 mA)

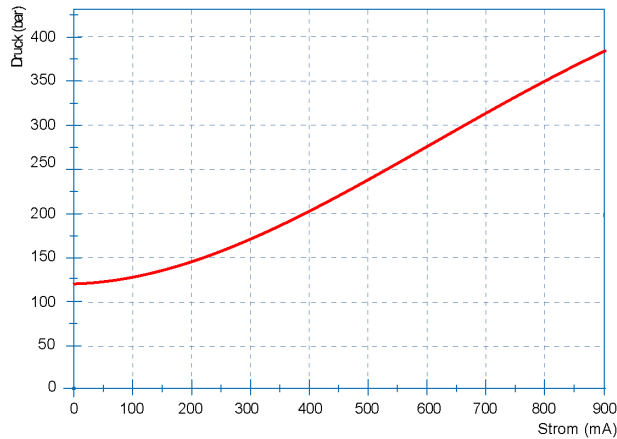

Volume Flow Characteristic:  
Volume flow as a function of the electric current (Q<sub>max</sub>: 400 l / min)  
Measuring orifice negative, current up to 350 l / min

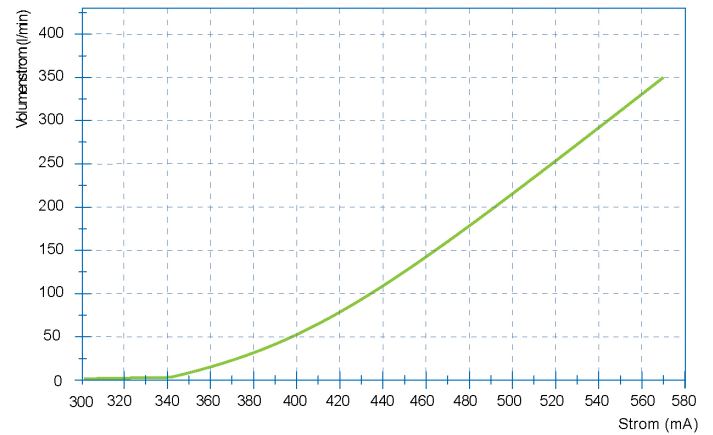

### 4.4 Characteristic 4: Pressure Setting (P)

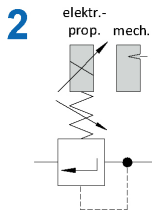

- For the electrical variant the power is supplied via a DEUTSCH plug DT04-2P or an AMP Junior Timer plug.
- For the mechanical version the limitation of the maximum pressure is done by a mechanical adjustment (see picture on the right)

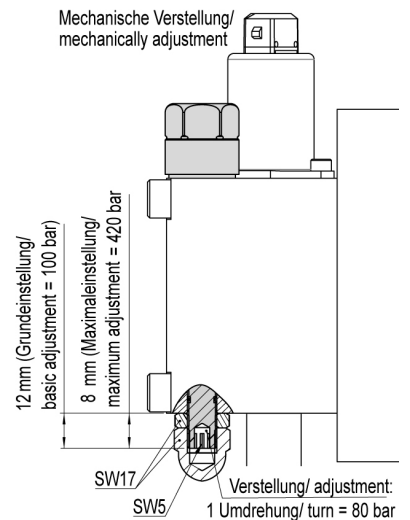

### 4.5 Characteristic 5: Volume flow setting (Q)

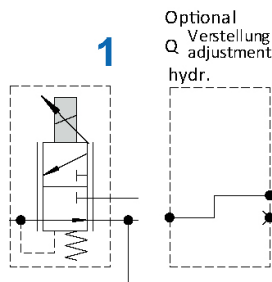

- For the electrical variant, the power is connected via a Deutsch DT04-2P or an AMP Junior Power Timer plug.
- For the hydraulically proportional version, the piloting signal is connected via a G1 / 4 port (see picture on the right).

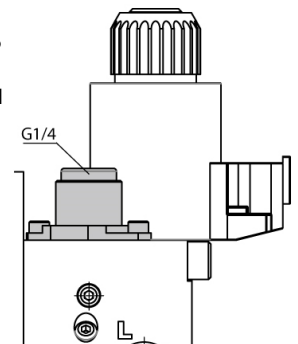

**4.6 Characteristic 6: Output flow rate**

The adjustment of the volume flow is done electrical-proportional by means of varying the electric current to the pilot valve (1). To achieve a high accuracy of the volume flow to be set, the use of a current-regulated (PWM) control is recommended. The pilot valve (1) can also be operated ON/OFF with 12V or 24 Volt. In this case, the volume flow limitation can be done mechanically.

**4.7 Characteristic 7: Check Valve (CV) or Throttle Check Valve (TCV)**

Specifies which Check Valve (CV) or Throttle Check Valve (TCV) will be used with the respective version of the flow control valve.

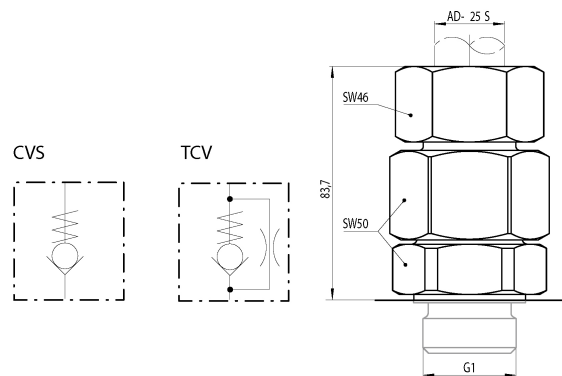

**4.8 Characteristic 8: Pressure relieve (H)**

For applications where the pressure to the attachment can not relieve itself when switched off, the flow control valve can optionally be ordered with a relieve nozzle. This nozzle is located between the connection to the consumer (H) and the tank connection (T) and is automatically used when the flow control valve is switched off.

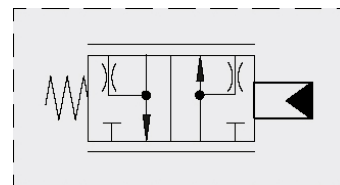

## 5 Installation

### 5.1 General remarks

- Observe all installation and safety information of the machine manufacturer.
- Only technically permitted changes are to be made on the machine.
- The user has to ensure that the device is suitable for the respective application.
- Application exclusively for the range of application specified by the manufacturer.
- Before installation or dismantling, the hydraulic system is to be depressurized.
- Settings are to be made by qualified personnel only.
- May only be opened with the approval of the manufacturer, otherwise the warranty is invalidated.

### 5.2 Connection suggestion



**NOTE**

The included connection recommendations are not guaranteed. The functionality and the technical specifications of the machine must be checked. It must be ensured that the construction machine is suitable in terms of technology and safety for the operation of the attachment.

- 1 - New consumer (e.g. Hammer)
- 2 - Flow control valve FC1X-2P
- 3 - Main control unit construction machine
- 4 - Switch valve (Signal for LS controller)
- 5 - Master pump

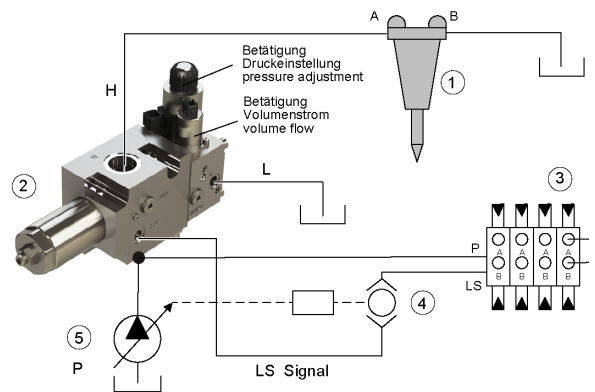

### 5.3 Installation - space

- Observe the connection labels.
- Observe the strength category and torsional moment/fastening torque of the clamp bolts.
- Do not damage seals and flange surface.
- The air must be exhausted from the hydraulic system.
- Ensure that the support element is level.
- Ensure that the valve is not bent during installation.
- Ensure that there is sufficient free space for setting and installation work.
- a. Install the flow valve on the support element using M10 bolts.
- b. Make electrical connections.



**CAUTION!** Hydraulic hoses must not come into contact with the flow control valve as they will suffer thermal damage.

#### 5.3.1 Tightening torque

Thread A	Strength class	Tightening torque Nm	C mm
M10	8.8	48	35

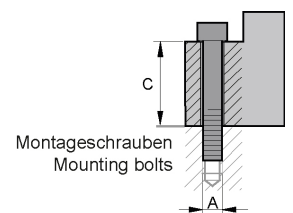

### 5.4 Setting the output flow rate



**ATTENTION** During operation, the valve can heat up to the oil temperature.

After loosening the counter-nut (2), the set-screw (1) can be used to mechanically set the maximum aperture.

- Screw in (CW): reduce the output volume
- Turning out (CCW): increase output flow

This setting is required when the flow control valve is switched to set the output flow rate. The setting can also be used with proportionally actuated valve to limit the output flow independently of the input signal.

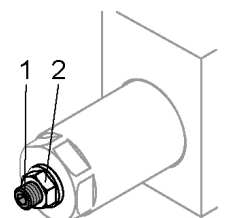



## **6 Notes, Standards and Safety Requirements**

### 6.1 General remarks

- The views in drawings are shown in accordance with the European normal projection variant

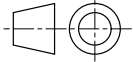

- A comma ( , ) is used as a decimal point in drawings
- All dimensions are given in mm

### 6.2 Standards

The following standards must be observed when installing and operating the valve:

- DIN EN ISO 13732-1:2008, Temperatures on accessible surfaces

## **7 Accessories**